

# Data Sheet



Article number: 432000200

Description: Rota-fix shaft-hub connection A 200x260  
Steel

Note: Not self centering. Medium-high torques.

## Measures

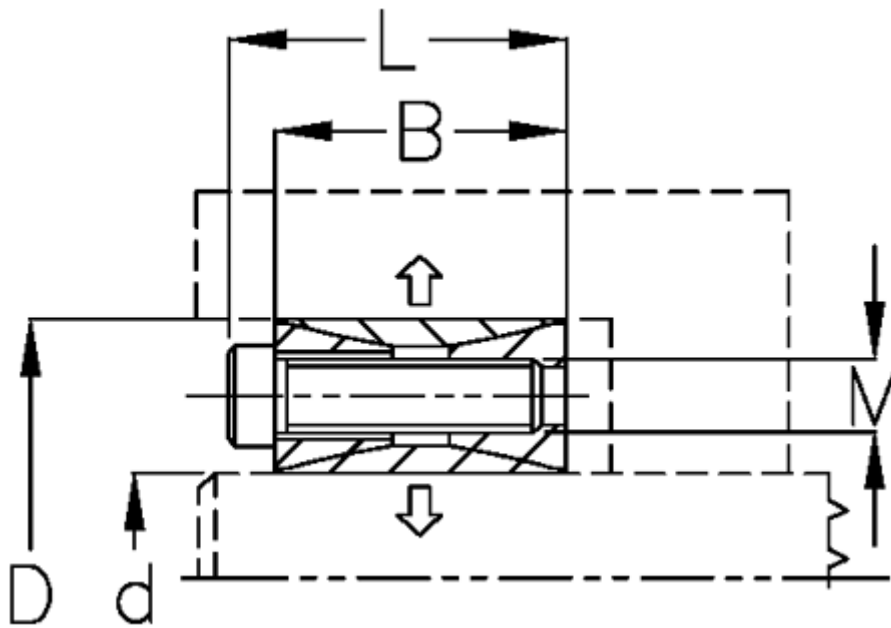

B mm	= 52
d H8 mm	= 200260
D mm	= 260
Fit tolerance	= Aksel k11-h11, Nav N11-H11
F kN torque	= 590.0
L mm	= 66
M mm	= M14
P N/mm <sup>2</sup> surface pressure on shaft/hub	= 131

Surface roughness	=
T N m torque	=
Ts N m bolt tightening torque	=